

Manual

PressureScout-LR

SignalFire Model: PressureScout/LR-PSIx-1BIS-xxxxx



The SignalFire Pressure Scout-LR is an Intrinsically Safe (certification pending) LoRaWAN® wireless pressure sensor with the following features:

- Powers integrated pressure sensor and radio for years with an internal battery
- Class 1 Division 1 Intrinsically safe system (pending)
- Rugged design for outdoor environments
- LoRaWAN® Radio for up to 10 mile range (SignalFire 900MHz proprietary radio available)
- ½" NPT Process connection standard
- Rapid pressure sampling with configurable alarms and report by exception
- Extremely low power and long battery life
- Reports Maximum, Minimum and Average pressures when configured for rapid pressure sampling
- Class A LoRaWAN® device. May be configured remotely via downlink messages
- Local or remote zeroing

Specifications

Enclosure Size	7.25" tall × 2.75" diameter
Power Source	Internal 19A/h Intrinsically Lithium Thionyl Chloride battery pack SignalFire Part Number: 1BIS
Battery Life	Battery Life: 2 -10+ years depending on sample and reporting frequency.
Temperature Rating	-40 DegF to + 140DegF (-40°C to +60°C)
Radio Frequency	LoRaWAN radio, internal antenna FCC ID: AU792U13A16858 IC: 125A-0055
Compliance	Certification Pending for use in Class I, Division 1 groups C and D. T3 EXi [EXi] FCC/IC Certified.
Pressure Sensor	PERFORMANCE AT 77°F / 25°C Accuracy: ±0.25% BFSL; ≤ ± 0.5% BFSL (> 10,000 PSI) Stability (1 year): ±0.25% FS, typical Over Range Protection: 2X Rated Pressure, Minimum Burst Pressure: 5X or 40,000 PSI (whichever is less) Pressure Cycles: >100 Million Process Connection: 1/2" NPTM 316L Stainless Steel Standard F250C Autoclave for pressure > 10,000 psi Other process connections/material available Standard Pressure Ranges: 0-100 psi, 0-500 psi, 0-1000 psi, 0-3000 psi, 0-5000 psi, 0-10,000 psi, 0-15,000 psi, 20,000 psi Low Pressure Ranges: 0-2 psi, 0-20 psi Operating Range: -40 to +176°F (-40 to +80°C) Compensated Range: 5°F to 150°F (-15°C to +65°C) TC Zero: <±1% of FS TC Span: <±1% of FS

LoRaWAN Radio

LoRaWAN compliant radio: supports Adaptive Data Rate (ADR)
Data Update Rates: User-selectable. 1 minute to 12 hours.
Range: Up to 10 miles (line of sight)
Radio Power: 19 dBm
Receive Sensitivity: -130 dBm
Radio Frequency: 902–928 MHz, LoRaWAN 1.0.4 compliant, OTAA provisioning, license-free ISM Band
Compliant with FCC Part 15 and Industry Canada.

Model Code

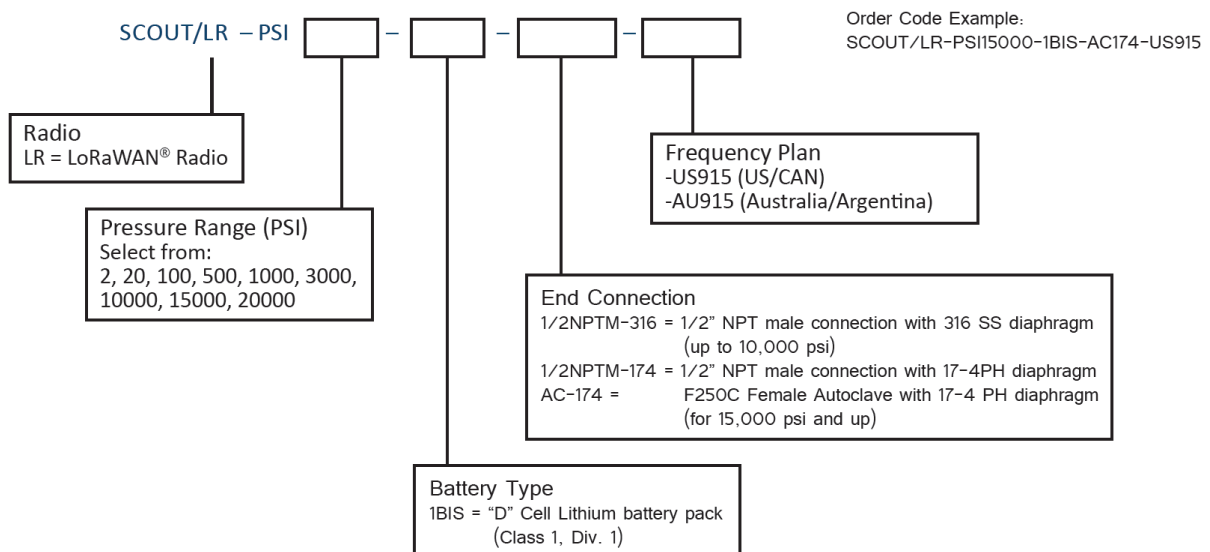

WARNING: Use of this equipment in a manner not specified by the manufacturer may impair the protection provided by the equipment.

AVERTISSEMENT: L'utilisation de cet équipement d'une manière non spécifiée par le fabricant peut nuire à la protection fournie par l'équipement.



WARNING: The use of any parts not supplied by the manufacturer violates the safety rating of the equipment.

AVERTISSEMENT: L'utilisation de pièces non fournies par le fabricant est contraire à la cote de sécurité de l'équipement.

Refer to control drawing 960-0112-01 for requirements when used in a Class I Division 1 area.

Reportez-vous à l'illustration de contrôle 960-0112-01 pour connaître les exigences lorsqu'elle est utilisée dans une zone de classe I division 1.

Contents

Specifications	2
Model Code.....	3
Control Drawing – Certification Pending	5
Description	6
Connections and Components.....	6
Setup	7
LoRaWAN Setup.....	9
Operation	10
LoRaWAN Network Operation.....	13
Uplink Data Packet Formats.....	15
Downlink Data Packet Formats.....	17
Pressure Sensor Zero Settings.....	18
Pressure Sensor Calibration Settings	19
Mounting and Care	20
Internal Lithium Battery Replacement.....	21
Configuration / Debug	21
Technical Support and Contact Information.....	22
APPENDIX - FCC and IC Statements	23

Control Drawing – Certification Pending

SignalFire Pressure Scout

Models: PressureScoutLR-PSIx-1BIS
x=pressure span

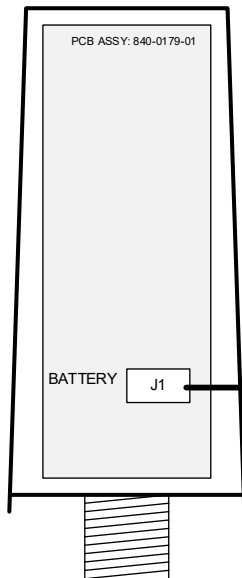

Power Source	
Ui/Vmax:	5.9 VDC
Ii:	3.1 A
Pi:	0.89 W
Ci:	9.66 uF
Li:	0.1 uH

SignalFire Telemetry			
Part Name	Control Drawing, Pressure Scout LR	Date	4/8/24
Part Number	960-0112-01	Rev	1.0
Page 1 of 1			

Class I, Division 1, Groups C and D	Ambient Temperature Limit: -40C to +60C Temperature Code: T3
<ul style="list-style-type: none"> • WARNING: Substitution of components may impair intrinsic safety. • Choose peripheral devices and associated apparatuses such that the following conditions are met: $U_i/V_{max} \geq U_o/V_{oc}$ $I_i/I_{max} \geq I_o/I_{sc}$ $P_i \geq P_o$ $C_o/C_a \geq C_i + C_{cable}$ $L_o/L_a \geq L_i + L_{cable}$ • When replacing the internal battery, only use SignalFire lithium battery model number 810-0030-01 (1BIS) • See SignalFire Instruction manuals numbers 960-0111-01 for installation requirements 	

CERTIFICATION PENDING

Description

The SignalFire Pressure Scout-LR is a low-power, battery-operated, wireless pressure-sensing device that utilizes the LoRaWAN® Network for communications. It periodically samples the built-in pressure transducer and transmits the reading wirelessly to a LoRaWAN® Gateway and Network Server.

The Pressure Scout-LR must be provisioned with certain parameters to operate the pressure sensor and communicate on a LoRaWAN® network. This is done using the SignalFire Toolkit application.

Connections and Components

Status LEDs

- The STATUS LED (green) blinks rapidly while attempting to join the network. If device is joined will blink once when a Check-In is forced from the Check-In button or the Toolkit
- The ERROR LED (red) will blink 3 times to indicate a failed join

Check-In Button

- If this button is pressed the Scout will take a reading from the integrated pressure sensor and send the data to the gateway. If the Scout is not joined, it will start a join attempt

Zero Button

- Allows the pressure sensor to be zeroed. Without any applied pressure to the sensor, hold the 'Zero' button down for 3 seconds to zero the pressure sensor. The status LED will come on and then blink twice to indicate that the sensor has been zeroed.

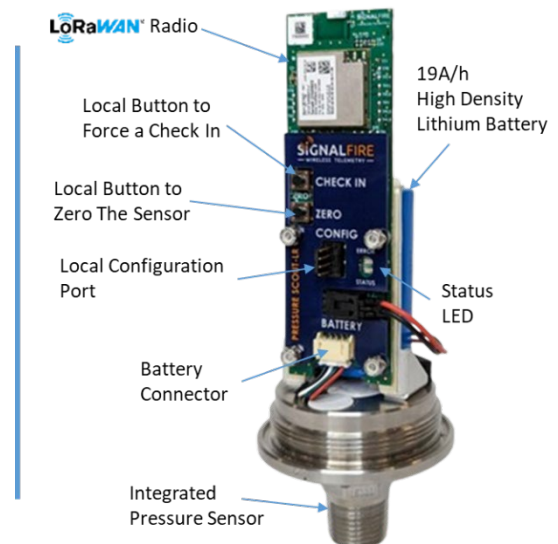

Setup

All settings are made using the SignalFire Toolkit PC application and a USB-serial programming cable available from SignalFire's website www.signal-fire.com.



WARNING: Perform the steps in this section (Setup) in a safe location only.

AVERTISSEMENT: Suivez les étapes de cette section (Configuration) dans un endroit sûr uniquement.

Using the SignalFire Toolkit

The SignalFire Toolkit application can be downloaded at www.signal-fire.com/customer. After installation, launch the software and the main toolkit window will open:

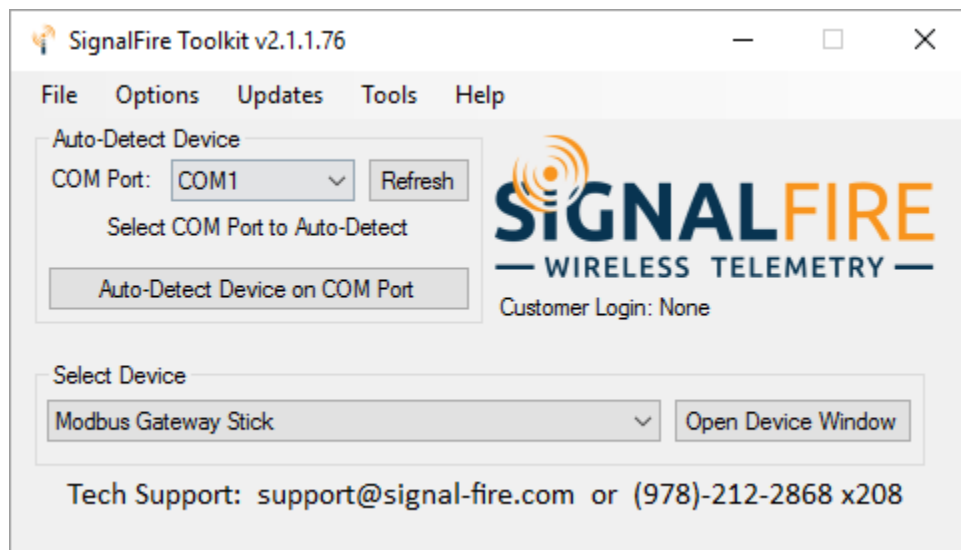

Select the COM port associated with the Pressure Scout-LR and click "Auto-Detect Device on COM Port." This will open the device configuration window, where all device settings can be configured.

The pressure sensor parameters are available on the main page.

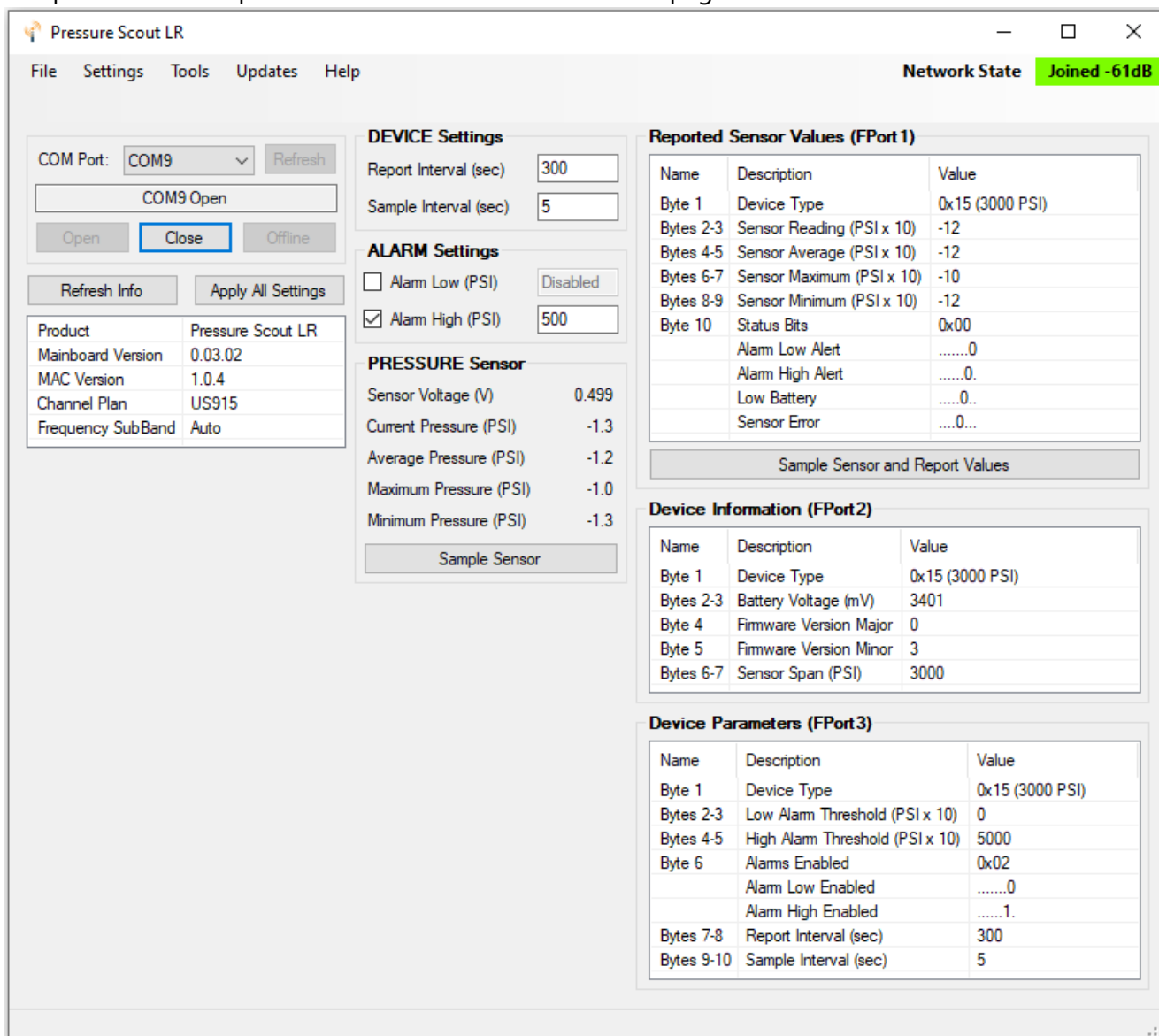

Figure 1: Pressure Scout-LR Main Page

Check-In Interval (sec): The minimum interval at which pressure samples are transmitted to the LoRaWAN® network, in seconds. Range: 60 sec - 43,200 sec (1 minute - 12 hours)

Sample Interval (sec): The interval at which the pressure transducer is sampled, in seconds. Range: 1 sec - 43,200 sec (1 second - 12 hours)

Low Alarm Enable and Threshold (PSI): The optional low pressure value that will trigger an immediate report to the LoRaWAN® network. While in a state of alarm, reports are sent at the Sample Interval, no faster than once per minute. When the alarm is cleared, a report will be sent within one minute or the last report, if still cleared.

High Alarm Enable and Threshold (PSI): The optional high pressure value that will trigger an immediate report to the LoRaWAN® network. While in a state of alarm, reports are sent at the Sample Interval, no faster than once per minute. When the alarm is cleared, a report will be sent within one minute or the last report, if still cleared.

LoRaWAN Setup

The device must be registered and joined with Over-The-Air (OTA) activation to a LoRaWAN® network server. This requires entering the 64-bit Device EUI and 64-bit Application EUI, as well as a 128-bit Application Key. The Application EUI (Join EUI) and Application Key can **optionally** be overwritten from the factory defaults to different values, as well as restored to the factory default values. The factory default Application Key cannot be read from the device and is only available on the information card inside the box of each device.



1. Select **MAC Settings** under the **Settings** pull-down menu.

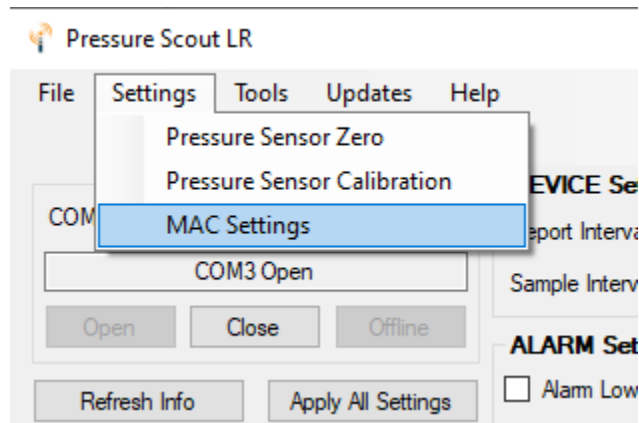

Figure 2: Select MAC Settings Page

2. Enter the desired Application EUI and/or Application Key. Press the **Set Device Settings** button to program the device with the new MAC settings.

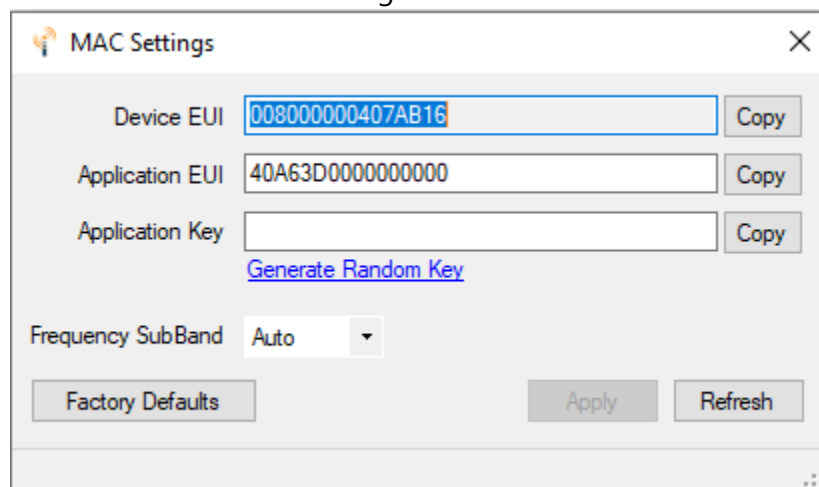

Figure 3: MAC Settings Page

Operation

The Pressure Scout-LR will power-up and sample the built-in pressure sensor at the configured **Sample Interval**. Each new pressure sensor sample is applied to running statistics of the minimum, maximum, and average pressure sensor values.

The Pressure Scout-LR will sample the pressure sensor values and report them to the network at the configured **Check-In Interval**. If the Check-In Interval is configured to be shorter than the Sample Interval, the pressure sensor will only ever be sampled at the Check-In Interval. The minimum, maximum, and average pressure sensor values are calculated over the configured Check-In Interval. For example, if the Check-In Interval is configured for 15 minutes, and the Sample Interval for 10 seconds, the pressure sensor values reported will be the minimum, maximum, and average of all the 10-second samples taken over the 15-minute Check-In Interval.

While reporting pressure sensor values, if the device is not joined to the network, an attempt to join the network is first performed using a Join Delay of 5 seconds. Once the device is successfully joined to the network, the pressure sensor values are sent in uplink data packets on Application Port (FPort) 1. Immediately after joining the network, and periodically every 12 hours, Device Information and Device Parameters are sent in uplink data packets on Application Ports (FPorts) 2 and 3, respectively.

If the device is unable to join for two (2) consecutive hours, the Check-In Interval and Sample Interval will both be temporarily raised to 15 minutes, if configured to be less than 15 minutes, until the device is successfully joined to the network again.

If the pressure sampled is above the **High Alarm Threshold** or below the **Low Alarm Threshold**, the corresponding Alarm High/Low Alert bit in the Status Bits field is set, and the pressure sensor values are reported to the network immediately. After an alarm is reported active, each pressure sample is reported to the network at a rate no faster than the one (1) minute since the last reported pressure sample.

If the pressure sampled is no longer above the High Alarm Threshold or below the Low Alarm Threshold, the Alarm High/Low Alert bit is cleared in the Status Bits and the pressure sensor values are reported to the network no sooner than the one (1) minute from the last reported sample.

Example 1

Sample Pressure at Report Interval

Measures the Pressure at the time of check in & Reports pressure measurement at time of check in

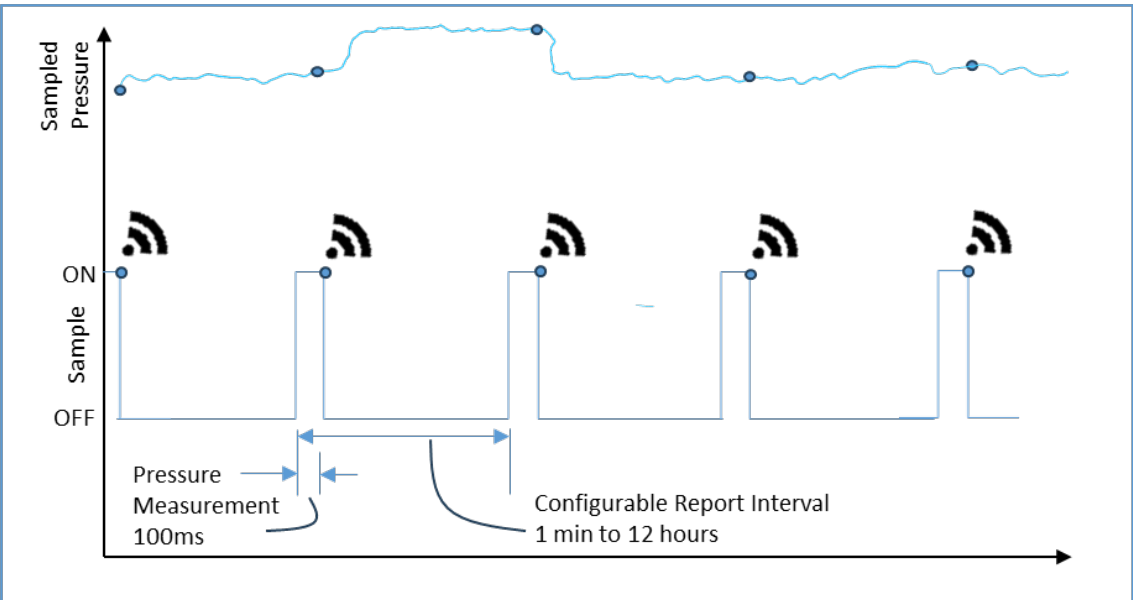

Measurement transmitted
 Measurement Sampled

Example 2

Multiple Samples Between Report Intervals

Measures multiple samples between Check-In's & Reports the min/max/avg of the samples + actual pressure at Check-In

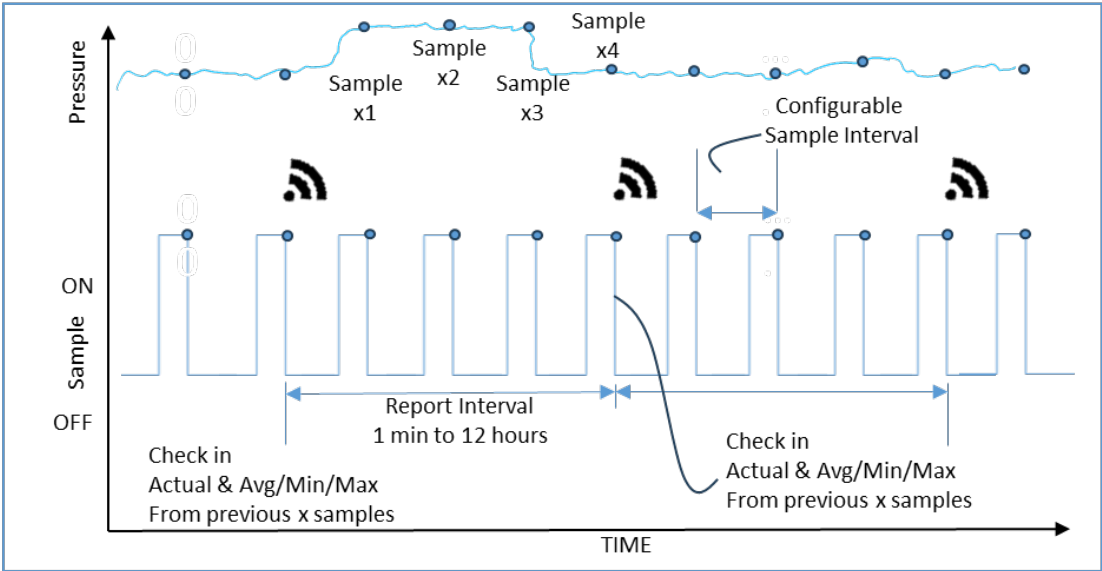



Measurement transmitted
 Measurement Sampled

Example 3

Triggered Reporting - Sampling between Report Interval

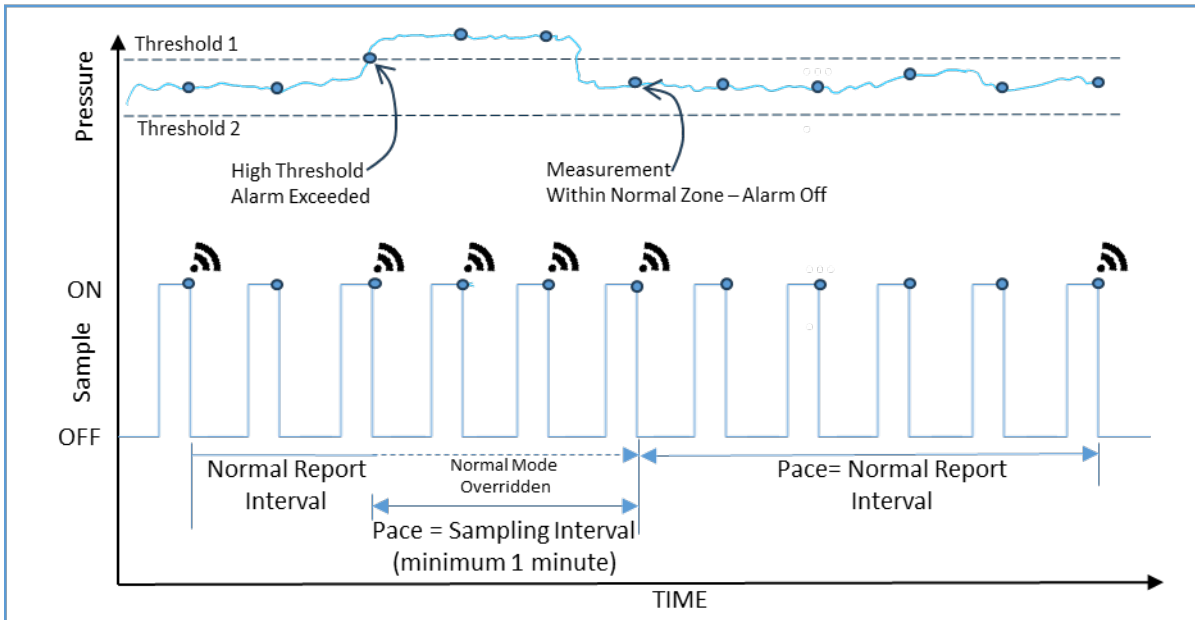
Pressure Reported When a Sample Meets A Threshold
Report Interval Changes To a Faster Pace



 Measurement transmitted
  Measurement Sampled

LoRaWAN Network Operation

The Pressure Scout-LR operates as a LoRaWAN® Class A device and will use all the available frequency sub-bands available for its region.

The Pressure Scout-LR uses Adaptive Data Rate (ADR) to optimize data rate, airtime and energy consumption. ADR requests are sent immediately after joining a network to adjust for the optimal data rate. Subsequent ADR requests are sent using an AckDelay of 32 uplinks and an AckLimit of 64 uplinks.

The Pressure Scout-LR uses network link check requests on every third (3) uplink packet to check for network connectivity. If three (3) consecutive link check requests go unanswered, the device is considered not be joined to the network anymore and will start attempting to rejoin the network on each Check-In Interval.

The Pressure Scout-LR does not request Acks on uplink packets, except on the first packet after setting the Alarm Low or Alarm High Alert bit to '1' in the Status Bits of FPort1. These critical uplink packets that set an Alarm Alert bit to '1' will request an Ack and be attempted three (3) times.

Reported Sensor Values (FPort 1)		
Name	Description	Value
Byte 1	Device Type	0x12 (100 PSI)
Bytes 2-3	Sensor Reading (PSI x 100)	195
Bytes 4-5	Sensor Average (PSI x 100)	195
Bytes 6-7	Sensor Maximum (PSI x 100)	195
Bytes 8-9	Sensor Minimum (PSI x 100)	195
Byte 10	Status Bits	0x00
	Alarm Low Alert0
	Alarm High Alert0.
	Low Battery0..
	Sensor Error0...

Sample Sensor and Report Values

Figure 4: Reported Sensor Value (FPort1)

Device Information and Device Parameters are sent in uplink data packets on Application Ports (FPorts) 2 and 3, respectively. Device Information (FPort2) and Device Parameters (FPort3) uplink packets are sent to the network immediately after joining the network, and every 12 hours after that, on the next Check-In Interval expiry.

Device Information (FPort2)		
Name	Description	Value
Byte 1	Device Type	0x12 (100 PSI)
Bytes 2-3	Battery Voltage (mV)	3542
Byte 4	Firmware Version Major	0
Byte 5	Firmware Version Minor	2
Bytes 6-7	Sensor Span (PSI)	100

Figure 5: Device Information (FPort2)

Device Parameters (FPort3)		
Name	Description	Value
Byte 1	Device Type	0x12 (100 PSI)
Bytes 2-3	Low Alarm Threshold (PSI x 100)	0
Bytes 4-5	High Alarm Threshold (PSI x 100)	0
Byte 6	Alarms Enabled	0x00
	Alarm Low Enabled0
	Alarm High Enabled0.
Bytes 7-8	Report Interval (sec)	300
Bytes 9-10	Sample Interval (sec)	300

Figure 6: Device Parameters (FPort3)

Uplink Data Packet Formats

NOTE: All 16-bit signed and unsigned integer types are encoded Big Endian (MSB...LSB)

FPort1 Uplink Data Packets contain the latest pressure sensor readings and statistics. FPort1 Uplink Data Packets are 10 bytes in length and are sent on every Check-In when joined to a network.

NOTE: Different pressure sensor spans use different multipliers of PSI x1, x10, x100, and x1000. This is shown as **PSIx** and will depend on the specific pressure sensor span and Device Type.

Byte	Description	Data Type	Ex. 1200C300650100FFFC02
1	Device Type	8-bit unsigned int	0x12 – Pressure Scout-LR – 100 PSI
2-3	Sensor Reading (PSIx)	16-bit signed int	0x00C3 – $(195 \div 100) = 1.95$ PSI
4-5	Sensor Average (PSIx)	16-bit signed int	0x0065 – $(101 \div 100) = 1.01$ PSI
6-7	Sensor Maximum (PSIx)	16-bit signed int	0x0100 – $(256 \div 100) = 2.56$ PSI
8-9	Sensor Minimum (PSIx)	16-bit signed int	0xFFFC – $(-4 \div 100) = -0.04$ PSI
10	Status Bits	8-bit unsigned int	0x01 – Alarm Low Alert

Table 1: FPort1 Uplink Data Packet Format

Device Types

- 0x10 Pressure Scout-LR – 2 PSI (x1000 multiplier)
- 0x11 Pressure Scout-LR – 20 PSI (x1000 multiplier)
- 0x12 Pressure Scout-LR – 100 PSI (x100 multiplier)
- 0x13 Pressure Scout-LR – 500 PSI (x10 multiplier)
- 0x14 Pressure Scout-LR – 1000 PSI (x10 multiplier)
- 0x15 Pressure Scout-LR – 3000 PSI (x10 multiplier)
- 0x16 Pressure Scout-LR – 5000 PSI (x1 multiplier)
- 0x17 Pressure Scout-LR – 10000 PSI (x1 multiplier)
- 0x18 Pressure Scout-LR – 15000 PSI (x1 multiplier)
- 0x19 Pressure Scout-LR – 20000 PSI (x1 multiplier)
- 0x1A Pressure Scout-LR – Unknown PSI (x1 multiplier)

Status Bits

- 0x00 None
- 0x01 Alarm Low Alert
- 0x02 Alarm High Alert
- 0x04 Low Battery
- 0x08 Pressure Sensor Error (out of range)

FPort2 Uplink Data Packets contain device information, including battery voltage, firmware version, and pressure sensor span. FPort2 Uplink Data Packets are 7 bytes in length and are sent immediately after joining a network, and periodically every 12 hours when performing a Check-In.

Byte	Description	Data Type	Ex. 120DD600020064
1	Device Type	8-bit unsigned int	0x12 – Pressure Scout-LR – 100 PSI
2-3	Battery Voltage (mV)	16-bit unsigned int	0x0DD6 – 3542 mV = 3.542 V
4	Firmware Version Major	8-bit unsigned int	0x00 – Firmware Version r0.02
5	Firmware Version Minor	8-bit unsigned int	0x02 – Firmware Version r0.02
6-7	Sensor Span (PSI)	16-bit unsigned int	0x0064 – 100 PSI

Table 2: FPort2 Uplink Data Packet Format

FPort3 Uplink Data Packets contain device parameters, including alarm thresholds, and report and sample intervals. FPort3 Uplink Data Packets are 10 bytes in length and are sent immediately after joining a network, and periodically every 12 hours when performing a Check-In. FPort3 Uplink Data Packets are also sent in response to receiving a Downlink Data Packet that sets a device parameter.

Byte	Description	Data Type	Ex. 1200C8251C03012C000F
1	Device Type	8-bit unsigned int	0x12 – Pressure Scout-LR – 100 PSI
2-3	Low Alarm Threshold (PSIx)	16-bit signed int	0x00C8 – $(200 \div 100) = 2.0$ PSI
4-5	High Alarm Threshold (PSIx)	16-bit signed int	0x251C – $(9500 \div 100) = 95.0$ PSI
6	Alarms Enabled	8-bit unsigned int	0x03 – High and Low Alarms Enabled
7-8	Check-In Interval (sec)	16-bit unsigned int	0x012C – 300 sec = 5 min (default)
9-10	Sample Interval (sec)	16-bit unsigned int	0x000F – 15 sec

Table 3: FPort3 Uplink Data Packet Format

Alarms Enabled Bits

- 0x00 None
- 0x01 Alarm Low Enabled
- 0x02 Alarm High Enabled

Downlink Data Packet Formats

Downlink commands can be queued to be delivered to the PressureScoutLR at its next report. The configurable parameters are the device parameters that are ported with FPort3.

These parameters can be configured all at once with a single message, or individually. The individual commands can be combined into a single message so up to 3 commands can be concatenated together in a single packet while still staying under the 11-byte packet limit.

Byte	Description	Data Type	Ex. 0100C8251C03012C000F
1	Packet Format	8-bit unsigned int	0x01 – defines message format
2-3	Low Alarm Threshold (PSIx)	16-bit signed int	0x00C8 – (200 ÷ 100) = 2.0 PSI
4-5	High Alarm Threshold (PSIx)	16-bit signed int	0x251C – (9500 ÷ 100) = 95.0 PSI
6	Alarms Enabled	8-bit unsigned int	0x03 – High and Low Alarms Enabled
7-8	Check-In Interval (sec)	16-bit unsigned int	0x012C – 300 sec = 5 min (default)
9-10	Sample Interval (sec)	16-bit unsigned int	0x000F – 15 sec

Table 4: Downlink Packet type 1

Byte	Description	Data Type	Ex. 0200C8
1	Packet Format	8-bit unsigned int	0x02 – defines message format
2-3	Low Alarm Threshold (PSIx)	16-bit signed int	0x00C8 – (200 ÷ 100) = 2.0 PSI

Table 5: Downlink Packet type 2

Byte	Description	Data Type	Ex. 03251C
1	Packet Format	8-bit unsigned int	0x03 – defines message format
2-3	High Alarm Threshold (PSIx)	16-bit signed int	0x251C – (9500 ÷ 100) = 95.0 PSI

Table 6: Downlink Packet type 3

Byte	Description	Data Type	Ex. 04012C
1	Packet Format	8-bit unsigned int	0x04 – defines message format
2-3	Check-In Interval (sec)	16-bit unsigned int	0x012C – 300 sec = 5 min (default)

Table 7: Downlink Packet type 4

Byte	Description	Data Type	Ex. 05000F
1	Packet Format	8-bit unsigned int	0x05 – defines message format
2-3	Sample Interval (sec)	16-bit unsigned int	0x000F – 15 sec

Table 8: Downlink Packet type 5

Pressure Sensor Zero Settings

The pressure sensor can be zeroed out to correct for any electrical offset. Zeroing can be performed via the Pressure Sensor Zero pull-down menu, or the "Zero" button on the Scout's front panel.

Leave the Pressure Scout open to atmospheric pressure (0PSI gauge). To zero without the ToolKit, simply hold the "Zero" button down for 3 seconds until the "ACT" light turns solid, and the Pressure Scout will apply a baseline offset.

To view the baseline zero offset, or to set the zero offset through the ToolKit, open the "Pressure Sensor Zero" window under the Settings tab. The current zero offset can be read back from the Pressure Scout, set with the "Zero Sensor" button, or erased. If a two-point calibration has been performed, this zero will add an extra offset to the offset produced by the two-point calibration.

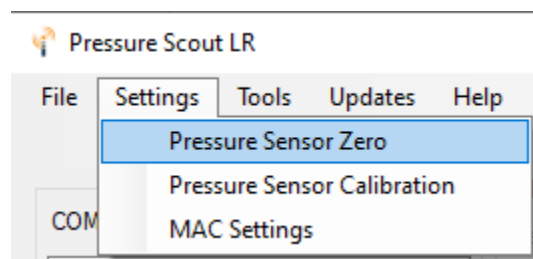

A negative deadband zone can be applied to the scaled floating point reading to remove small negative values. The default is "0". The deadband zone can be set in whole number increments which work as follows: Any negative reading within the defined "deadband" will be reported as zero. Any values below the deadband will be reported as the actual value. In the example below, any reading from 0PSI down to -2PSI will be reported as 0, and anything lower than -2PSI will be reported as the actual vacuum pressure.

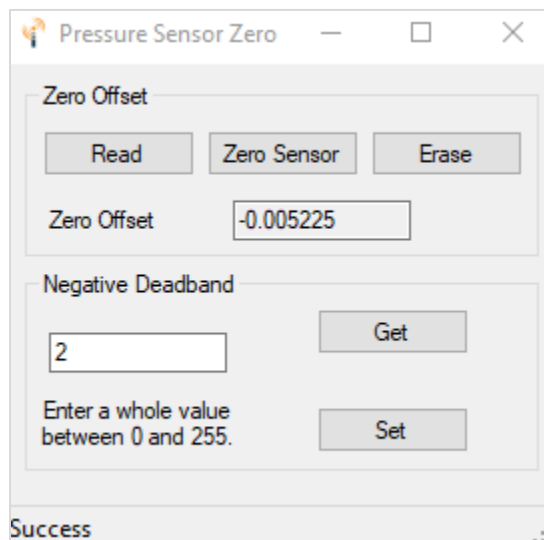

Zero Offset and Negative Deadband settings.

Pressure Sensor Calibration Settings

For more accurate results, a two-point calibration is available through the Pressure Sensor Calibration window, under the Settings drop-down menu. This will apply both a zero offset and a gain factor. **This calibration will remove any zero offset previously performed.**

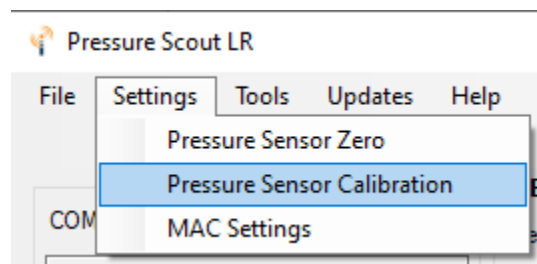

Click "Read Calibration" to read the current gain and offset, or click "Erase Calibration" to reset the gain to 1 and offset to 0.

To perform calibration, the user must supply two known, stable pressures, preferably with an external gauge. Ideally, the first pressure should be open atmospheric pressure (0 PSI), and the second should be at full scale, or at a minimum at least half of the sensor span. For example, if the Pressure Scout is a 0 – 1,000PSI unit, the low calibration input should be 0 PSI, while the high calibration input should be greater than 500PSI (ideally 1,000PSI). **It is crucial that the reference pressures are stable.**

First, apply the low pressure, allow it to stabilize, enter the calibration gauge reading into the "Low Calibration Input" field, and click "Set." Then apply the high pressure, allow it to stabilize, enter the calibration gauge reading into the "High Calibration Input", and click "Set/Cal". The Gain Factor and Offset fields will populate below, and will be automatically saved and will be applied to all future pressure readings.

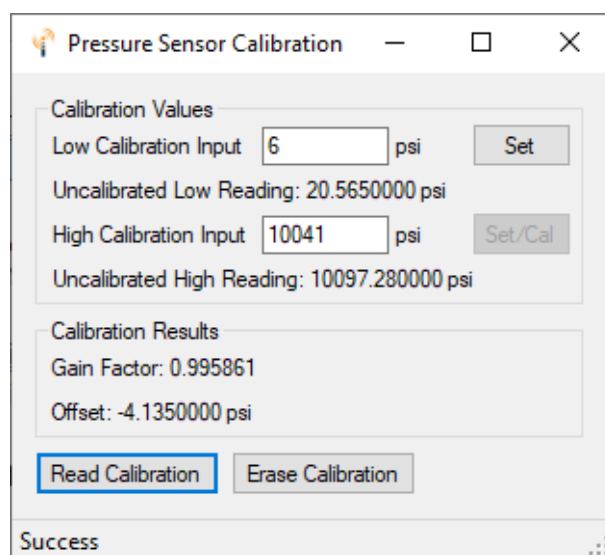

Pressure Sensor Calibration Settings

Mounting and Care

The Pressure Scout-LR unit comes with an integrated pressure sensor with a 1/2" MNPT process fitting. The Scout is mounted directly to the pressure source. It is important to mount the Scout so it is vertically orientated with the pressure fitting facing down.



WARNING: The Pressure Scout-LR must be mounted in a location free of high vibrations. Over time vibrations can damage the Sentinel or battery pack, which could impair its safety ratings. Do not mount directly to continuous vibrating equipment such as pumps or compressors.

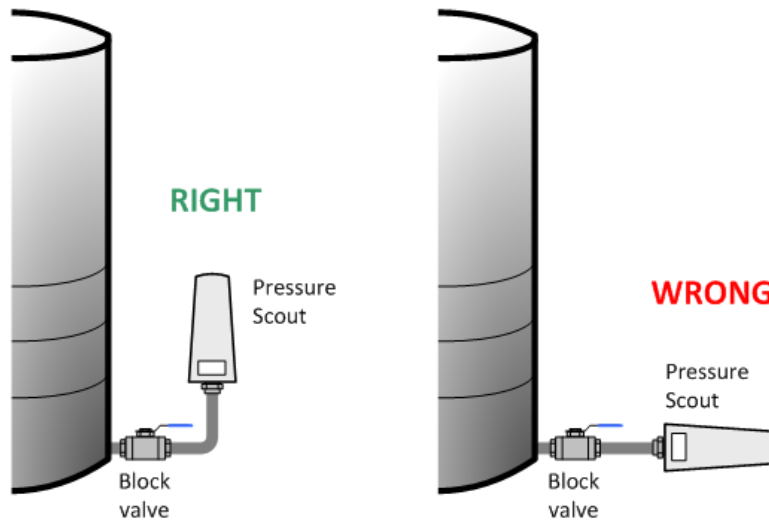

How you install the Pressure Scout-LR may also depend on the process fluid. Refer to the diagram below for installation on gas, steam, or liquid.

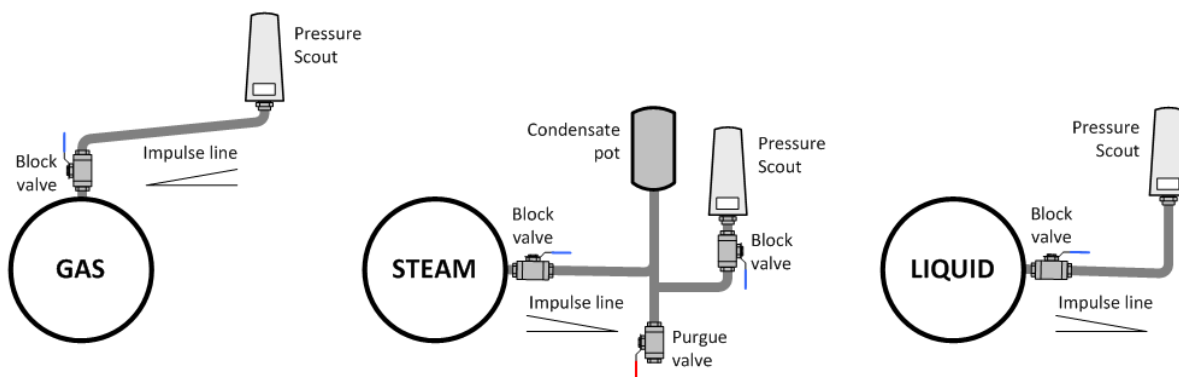

Internal Lithium Battery Replacement

Battery Packs can be changed with the node in place.

1. Unscrew the cover from the base.
2. Unplug the battery from the PCB, by depressing the locking clip on the connector.
3. Remove/replace battery
4. Connect the battery to the main PCB battery connector.
5. Install the enclosure cover.



WARNING: Use of any battery other than the SignalFire part number 810-0030-01 (1BIS) will impair the protection provided by the equipment.

AVERTISSEMENT: L'utilisation d'une pile autre que la référence SignalFire 810-0030-01 (1BIS) compromettra la protection fournie par l'équipement.

Cleaning Instructions

The outside of the enclosure may be cleaned with water, mild soap, and a damp cloth as needed. High pressure washing is not recommended.



WARNING: Electrostatic Discharge Hazard! Care must be taken to avoid the potential of creating a change on the enclosure or antenna. Do not wipe with a dry cloth. Do not brush against the enclosure with clothing or gloves.

AVERTISSEMENT: Risque de décharge électrostatique! Il faut veiller à éviter tout risque de changement de l'enceinte ou de l'antenne. Ne pas essayer avec un chiffon sec. Ne pas brosser contre l'enceinte avec des vêtements ou des gants.

Configuration / Debug



WARNING: Only connect to the debug port in a safe area!

AVERTISSEMENT: Se connecter uniquement au port de débogage dans une zone sûre!

Debug and configuration information is available if a connection is made via the debug port on the main board. A USB converter cable (USB-Serial-4PIN, available from SignalFire) must be used for this interface.

Debug and advanced configuration may be done using the SignalFire Toolkit PC application.

Technical Support and Contact Information

SignalFire Telemetry
140 Locke Dr., Suite B
Marlborough, MA 01752
(978) 212-2868
support@signal-fire.com

Revision	Date	Changes/Updates
1.0	4/4/24	Initial release
1.2	6/12/24	Added packet timing examples

APPENDIX - FCC and IC Statements

Changes or modifications not expressly approved by SignalFire Telemetry, Inc could void the user's authority to operate the equipment.

This device complies with Part 15 of the FCC Rules. Operation is subject to the following two conditions: (1) this device may not cause harmful interference, and (2) this device must accept any interference received, including interference that may cause undesired operation.

This equipment has been tested and found to comply with the limits for a Class B digital device, pursuant to Part 15 of the FCC Rules. These limits are designed to provide reasonable protection against harmful interference in a residential installation. This equipment generates, uses and can radiate radio frequency energy and, if not installed and used in accordance with the instructions, may cause harmful interference to radio communications. However, there is no guarantee that interference will not occur in a particular installation. If this equipment does cause harmful interference to radio or television reception, which can be determined by turning the equipment off and on, the user is encouraged to try to correct the interference by one of the following measures:

- Reorient or relocate the receiving antenna.
- Increase the separation between the equipment and receiver.
- Connect the equipment into an outlet on a circuit different from that to which the receiver is connected.
- Consult the dealer or an experienced radio/TV technician for help.

WARNING!

FCC and IC Radiation Exposure Statement:

This equipment complies with FCC's and IC's RF radiation exposure limits set forth for an uncontrolled environment under the following conditions:

1. This equipment should be installed and operated such that a minimum separation distance of 20cm is maintained between the radiator (antenna) & user's/nearby person's body at all times.
2. This transmitter must not be co-located or operating in conjunction with any other antenna or transmitter.

Industry Canada Class B Notice

This Class B digital apparatus meets all requirements of the Canadian Interference-Causing Equipment Regulations.

Cet appareil numérique de la classe B respecte toutes les exigences du Règlement Canadien sur le matériel brouilleur.

This device complies with Industry Canada license-exempt RSS standard(s). The operation is permitted for the following two conditions:

1. the device may not cause interference, and
2. this device must accept any interference, including interference that may cause undesired operation of the device.

Le présent appareil est conforme aux CNR d'Industrie Canada applicables aux appareils radio exempts de licence. L'exploitation est autorisée aux deux conditions suivantes:

1. l'appareil ne doit pas produire de brouillage, et
2. l'appareil doit accepter tout brouillage radioélectrique subi, même si le brouillage est susceptible d'en compromettre le fonctionnement.