

Interface Manual

Sentinel Node Digital

SignalFire Model: Sentinel-DI-XXXX



The SignalFire Sentinel Node is an Intrinsically Safe device with the following features:

- Two counter/frequency inputs, up to 2kHz. Open drain or pulse input supported
- Reports state of dry contact inputs, open/closed
- Optional report on state change
- Two 32bit count totalizers
- Low power operation from an intrinsically safe high capacity lithium primary battery pack
- Optional solar battery system for routing nodes, high power draw sensors, or rapid data collection
- Sends data to a SignalFire Buffered Modbus Gateway
- Settable (DIP switch) Modbus ID

Specifications

2

Enclosure Size	3.5" tall × 5.0" wide × 5.0" deep
Power Source	Internal IS Lithium battery pack <i>SignalFire Part Number: 3BIS</i> External Solar battery system <i>SignalFire Part Number: Sentinel-HCSolar</i> DC-DC Converter <i>SignalFire Part Number: DCDC-Sentinel</i> Other external power supply meeting the power entity parameters from the control drawing.
Temperature Rating	-40°C to +60°C
Radio Frequency	902-928MHz Ism Band, FHSS radio, internal antenna
Compliance	Certified for use in Class I, Division 1 groups C and D. EXi [EXi] FCC/IC Certified.



WARNING: Use of this equipment in a manner not specified by the manufacturer may impair the protection provided by the equipment.



WARNING: The use of any parts not supplied by the manufacturer violates the safety rating of the equipment.

The associated apparatus provides intrinsically safe outputs.

L'appareil associé fournit des sorties à sécurité intrinsèque.

Refer to control drawing "Sentinel – Control Drawing – Digital and Turbine" under Technical Documents for requirements when used in a Class I Division 1 area.



Marlborough, MA USA
www.signal-fire.com

S/N:SD000001

Model: SENTINEL-DI-XXXX



Intertek 4003827

CLASS I, DIVISION 1 GROUPS C, D
TEMP CODE: T3
AMBIENT TEMP: -40°C to +60°C
CONFORMS TO UL STD 913
CERTIFIED TO
CAN/CSA STD C22.2 NO. 157
FCC ID: W8V-SENTINEL
IC: 8373A-SENTINEL

ENTITY PARAMETERS

INPUT POWER: INPUT SIGNAL (J7):
Vmax = 5.9 Vdc Vmax = 30 Vdc
Imax = 3.1 A Imax = 100 mA
Pmax = 0.8 W Ci = 0.01 uF
Ci = 23.3 uF Li = 1.0 nH
Li = 4.08 uH

Exi
[Exi]

INTRINSICALLY SAFE
SECURITE INTRINSEQUE
INTRINSICALLY SAFE WHEN CONNECTED
PER SIGNALFIRE DRAWING 960-0028-01

WARNING: POTENTIAL
ELECTROSTATIC DISCHARGE
HAZARD! SEE INSTRUCTIONS

AVERTISSEMENT: DANGER
POTENTIEL DE DECHARGES
ELECTROSTATIQUES: VOIR LES
INSTRUCTIONS

WARNING: USE OF ANY BATTERY
OTHER THAN SIGNALFIRE 810-0008-02
or SENTINEL-SOLAR
MAY IMPAIR INTRINSIC SAFETY

AVERTISSEMENT: LA SUBSTITUTION
DE COMPOSANTS PEUT COMPROMETTRE
LA SECURITE INTRINSEQUE

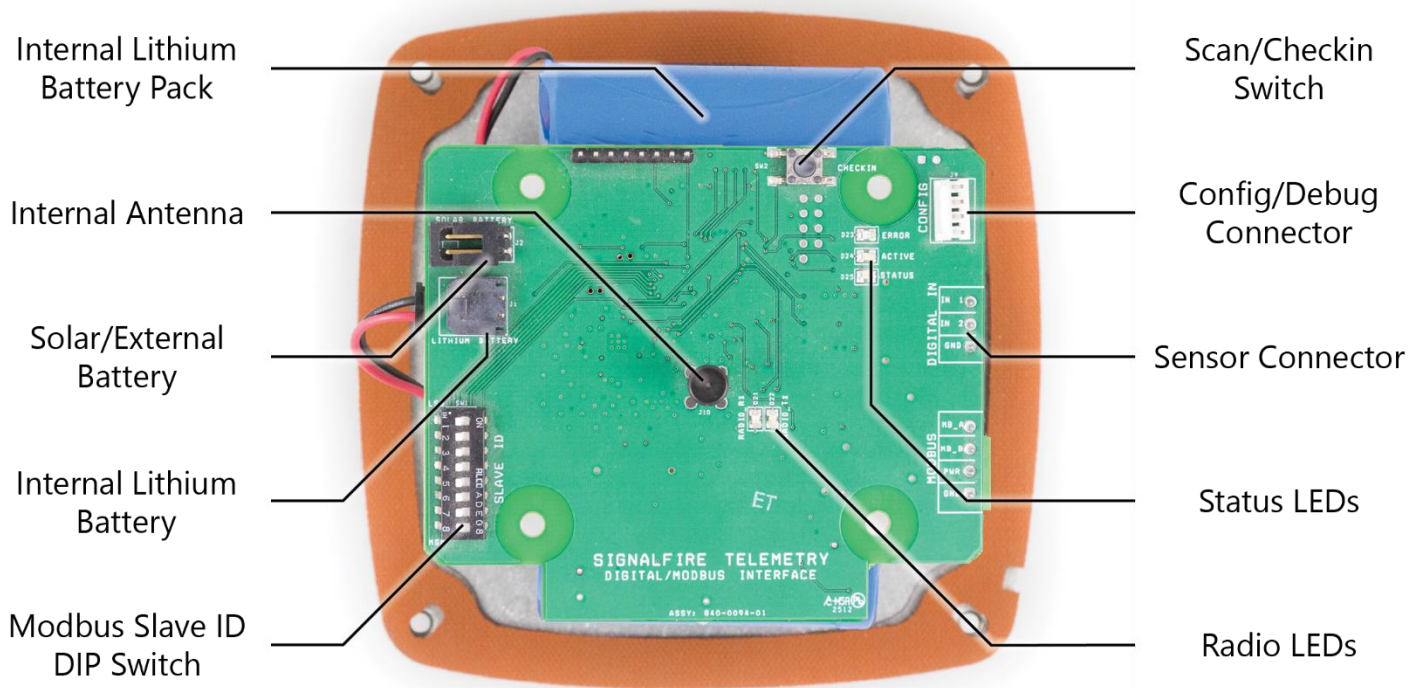

Radio LEDs

- The Radio TX LED (**green**) flashes each time a radio packet is sent. This LED will blink rapidly while searching for the radio network.
- The Radio RX LED (**red**) blinks on each received radio packet.

Status LEDs

- The Active LED (**green**) will blink at boot up and will blink rapidly for 2 seconds before the counter values are sent to the gateway.
- The ERROR LED (**red**) will blink to indicate an error condition.

Scan/Checkin Button

- If this button is pressed the Sentinel will send the current counter values to the gateway.

Setup

5

The nodes need to be set up for correct operation before being fielded. The configurable items include:

- Network selection
- Check-in period selection
- Modbus ID setting

All settings are made using the SignalFire Toolkit PC application and a serial programming cable. The Modbus ID can also be set using the DIP switch.



WARNING: Perform the steps in this section (Setup) in a safe location only.

Using the SignalFire Toolkit

The SignalFire Toolkit application can be downloaded at www.signal-fire.com/customer. After installation, launch the software and the main toolkit window will open:



Select the COM port associated with the Sentinel Node and click "Auto-Detect Device on COM Port." This will open the device configuration window, where all device settings can be configured.

Sentinel Digital

File Settings Updates Tools Help

COM Port: COM10 Refresh

Open **1** Offline

Connect/Update

Product	DIGITAL
Slave ID	43
Node Name	Digital01
Radio Connectivity	DISCONNECTED
Mainboard Version	0.50
Radio Version	2.50 (sleeping)
Radio Address	3015
Corporate ID	7
Radio Mode	Sleeping
Radio Network	1
Radio Network Group	1
Radio Power (dBm)	-4
Checkin Interval	1 minute 2
State Change Checkin	On
Sensor On Time (sec)	N/A
Sensor Power Mode	N/A
Scale A Type	N/A
Scale A Low Value	N/A
Scale A High Value	N/A
Adaptive Reporting	N/A

Set Corporate ID **3** Help

Enable Encryption Set

Corporate ID: 7 Set

Reported Sensor Values

Address	Description	Value
3010-3011	Counter1 (counts)	11
3012	Counter1 State	0
3013	Avg. Freq1 (Hz x10)	0
3014	Inst. Freq1 (Hz x10)	0
3015	Counts/Minute1 (x10)	0 5
3016-3017	Counter2 (counts)	16
3018	Counter2 State	0
3019	Avg. Freq2 (Hz x10)	0
3020	Inst. Freq2 (Hz x10)	0
3021	Counts/Minute2 (x10)	0
65532	Battery Voltage (mV)	3583

Update Reported Sensor Values

Settings

Slave ID 43 Set

Node Name Digital01 Set

Radio Mode Sleeping Set

Radio Network 1 Set

Radio Network Group 1 Set

Checkin Interval 1 minute Set

State Change Checkin On Set

Sensor On Time (sec) Set

Sensor Always On **6** Set

Sensor Power Mode Set

Scale A Type Set

Scaling A Low Value Set

Scaling A High Value Set

New Battery Life Estimate: 10+ years **7**

Success

- | | | | |
|---|-----------------------------------|---|--------------------------|
| 1 | Serial Port Settings | 2 | Sentinel Information |
| 3 | Set Corporate ID / Encryption Key | 4 | Status of Last Operation |
| 5 | Reported Sensor and HART Values | 6 | Sentinel Settings |
| 7 | Battery Life Estimate | | |

Network Setting

The network is set using the SignalFire Toolkit. The network, network group, and corporate ID/encryption key settings must match those of the gateway for them to communicate.

7



Radio Network: 3
Radio Network Group: 0
Set

Encryption

To protect your over-the-air data and prevent tampering, SignalFire networks come with encryption. Legacy products use a Corporate ID, but can be switched over to use an encryption key if the firmware and ToolKit are up to date.

To set up a legacy Sentinel to use encryption, click the checkbox labeled **Enable Encryption** inside the **Set Corporate ID** box. All newer Sentinels come with this option enabled with "signalfire" as the default encryption key.

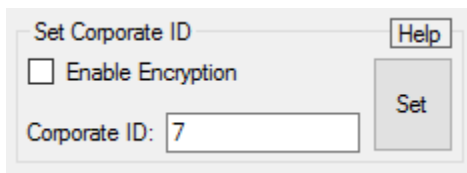

Set Corporate ID
 Enable Encryption
Corporate ID: 7
Set

Corporate ID

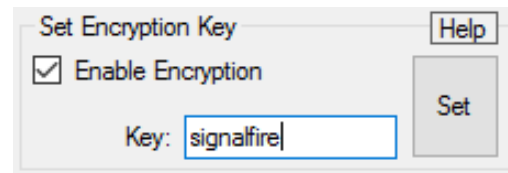

Set Encryption Key
 Enable Encryption
Key: signalfire
Set

Encryption Enabled

The box will then change into a **Set Encryption Key** box, and it will prompt instead for the encryption key you would like to use. Note that keys may not contain spaces or angle brackets. Enter it and then press **Set**. If you are setting up a new network, you will need to set the encryption key on all of your devices. If you are adding a Sentinel to a legacy network, you can simply set the Corporate ID without clicking the Enable Encryption box, and it will remain compatible with the older system.

It is also possible to hide your encryption key so it cannot be read. This is the most secure option, but if you forget your key, there is no way to recover it – you have to reset the key on every device on its network. To enable this option, select **Set Encryption Key Unrecoverable** under the **Settings** menu.

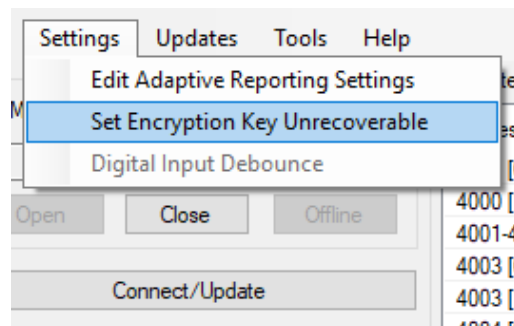

Setting the encryption key to be unrecoverable

Modbus ID

The Modbus ID can be set with the SignalFire Toolkit, or with the DIP switch located on the device on older models. The DIP switch takes an 8-bit binary input which is converted into a Modbus ID from 1 to 240. In the picture below switch 1 and 2 are on, which is 00000011 and results in a Modbus ID of 3. The least significant bit (LSB) is on the right and is labeled 1 above the row of switches. The Sentinel must be power cycled after setting the DIP switch. *Note: The DIP switch must be set to 0 (all switches off) in order to set the Modbus ID with the SignalFire Toolkit.*

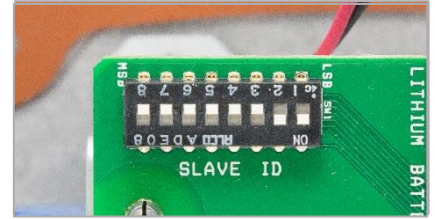

Sensor Connections

Wiring Requirements

To ensure intrinsic safety is maintained it is required that the installer follow these guidelines when connecting sensors to the SignalFire node. See pictures for proper wire routing examples.

- Sensor wires entering the enclosure must be run as pictured.
- The battery wire must be routed through the battery cable hold-down clamp.
- Strip the wires so that there is minimal exposed un-insulated wire when inserted into the screw terminal.
- All wiring should be neat and orderly.

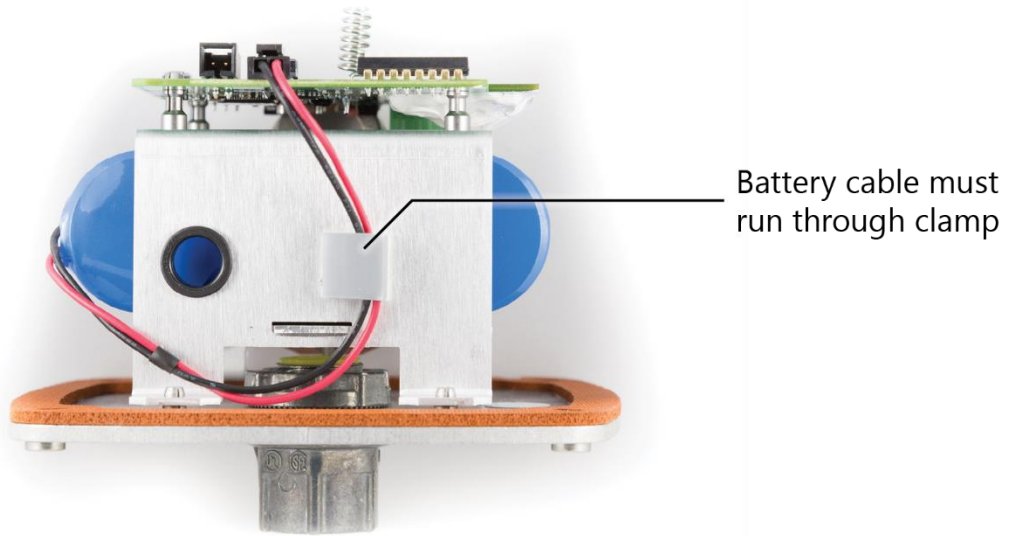

Plug the internal lithium battery pack into the connector labeled LITHIUM BATTERY as show below. Be careful to insert the battery connector as pictured with the locking tab facing up.

Forcing the battery connector in backward or into the SOLAR BATTERY connector can damage the battery pack fuse making it inoperable.

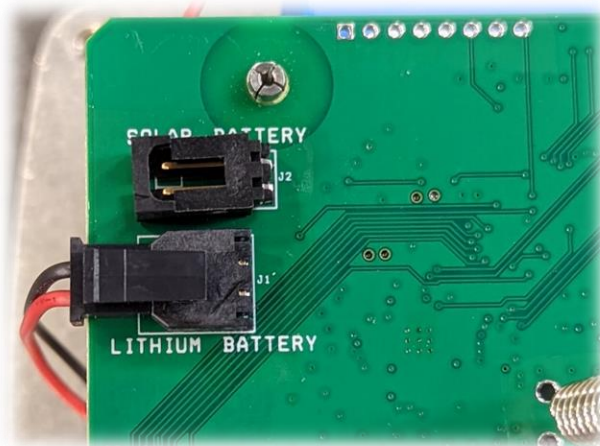

Only connect either the Lithium batter OR the Solay battery. **Never connect both at the same time.**

Sensor cable should be routed as shown

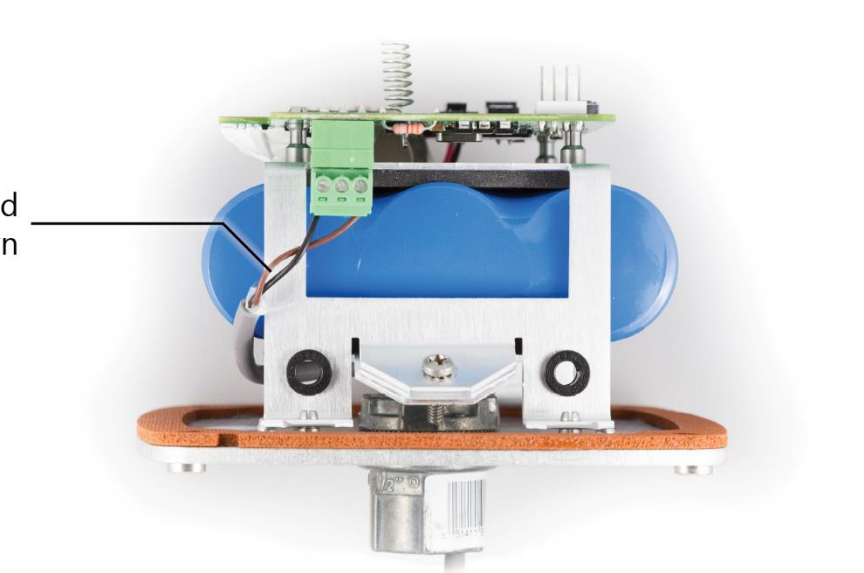

Sensor Connection

The Sentinel Node has two digital input channels; open or both may be used.

Each counter input may be open collector type (sinking ground), dry contact inputs, or voltage pulse type, note that voltage pulses must pull the input high/low. The inputs can count up to 2000 Hz.

The digital outputs may be connected to the board as shown in the following diagrams:

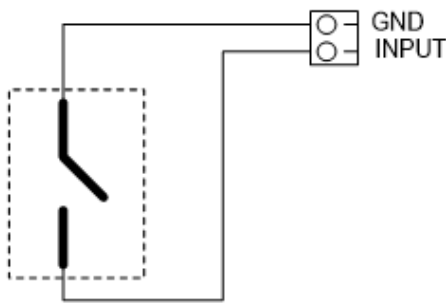

Dry Contact Connection

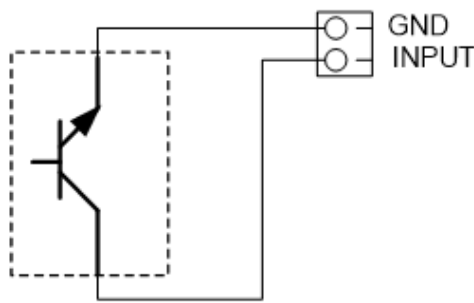

Open Collector Connection

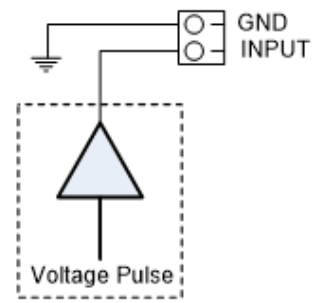

Voltage Pulse Connection

The counts accumulate, and the current counts are stored into non-volatile memory every 15 seconds. If the system is reset the counts will revert to the last stored value from non-volatile memory.

The system also reports the state of the contact closure input (open or closed) at the time of check-in.

Digital Input Debounce

In cases where it is desired to accurately totalize digital input counts it may be necessary to enable the digital input debounce timer. The debounce timer is useful when dealing with dry contacts that may otherwise produce extra counts when they close. To enable the digital debounce, open the configuration window for the node in the SignalFire Toolkit and select **Digital Input Debounce** from the **Settings** menu. A typical value for a dry contact would be 100mS. Any extra counts due to contact bounce within the debounce time setting will be ignored.

Digital Input State Latch

The state latch feature is useful in cases when the state of one or both of the digital inputs is “latched” to a value for a configurable number of seconds. This is useful in a cases where a fast transition would be sensed by the Sentinel by may happen too quickly to be read from the Gateway. The state latch feature is configured using the ToolKit. For example, with if the state latch is set to latch closed for 3 seconds, then any close sensed on the digital input will be reported as closed for 3 seconds even in the input opens in less than 3 seconds.

Remote Modbus Register Mapping

12

The Sentinel Node sends data to a SignalFire Telemetry Modbus Gateway. The data that is sent to the gateway is available at the gateway in registers where it can then be read by a Modbus RTU. Consequently, the node needs to have a unique (to the network it is in) Modbus ID which the gateway will use to store its unique data.

Modbus Registers

Every check-in period, the sensors are read and data is sent to the gateway. The gateway will save the data under the set Modbus ID in 16-bit registers. The register map for this system is below.

Register Map

Register Number	Register Address (Offset)	Description
43011-43012	3010-3011	32-bit Hardware counter, 3010=high word (two registers)
43013	3012	Digital Input state (1=closed, 0=open)
43014	3013	Average frequency over the last check-in period times 10
43015	3014	Frequency over 2 seconds at check-in time times 10
43016	3015	Avg. counts per minute over the check-in period times 10
43017-43018	3016-3017	32-bit Hardware counter, 3016=high word (two registers)
43019	3018	Digital Input state (1=closed, 0=open)
43020	3019	Average frequency over the last check-in period times 10
43021	3020	Frequency over 2 seconds at check-in time times 10
43022	3021	Avg. counts per minute over the check-in period times 10
49987	9986 or 65523	Status (0=no errors, 1=low battery, 2=failed sensor read, 3=low battery and failed sensor read)
49988	9987 or 65524	Major revision number for the mainboard
49989	9988 or 65525	Minor revision number for the mainboard
49990	9989 or 65526	Major revision number for the radio
49991	9990 or 65527	Minor revision number for the radio
49992	9991 or 65528	High 16 bits of SFTS node address
49993	9992 or 65529	Low 16 bits of SFTS node address (the radio ID)
49994	9993 or 65530	Modbus ID readback
49995	9994 or 65531	Received signal strength of last packet from the Sentinel
49996	9995 or 65532	Battery voltage of the Modbus client, in millivolts
49997	9996 or 65533	Minutes until this Sentinel will time out, unless new data is received
49998	9997 or 65534	Number of registers cached for this device
49999	9998 or 65535	Remote device type. 44 for Sentinel Digital

Note: The status registers are only available from the 49987-499999 (9986-9998) address range if the gateway is running firmware 7.52 or higher.

Mounting and Care

The unit comes with a watertight ½" NPT conduit fitting on the bottom mounting plate. The Sentinel is then directly mounted to the sensor with a short section of conduit.

Direct Mount to Sensor with Short Conduit

This mounting method uses a short conduit run from the sensor and the unit is held in place by the conduit.

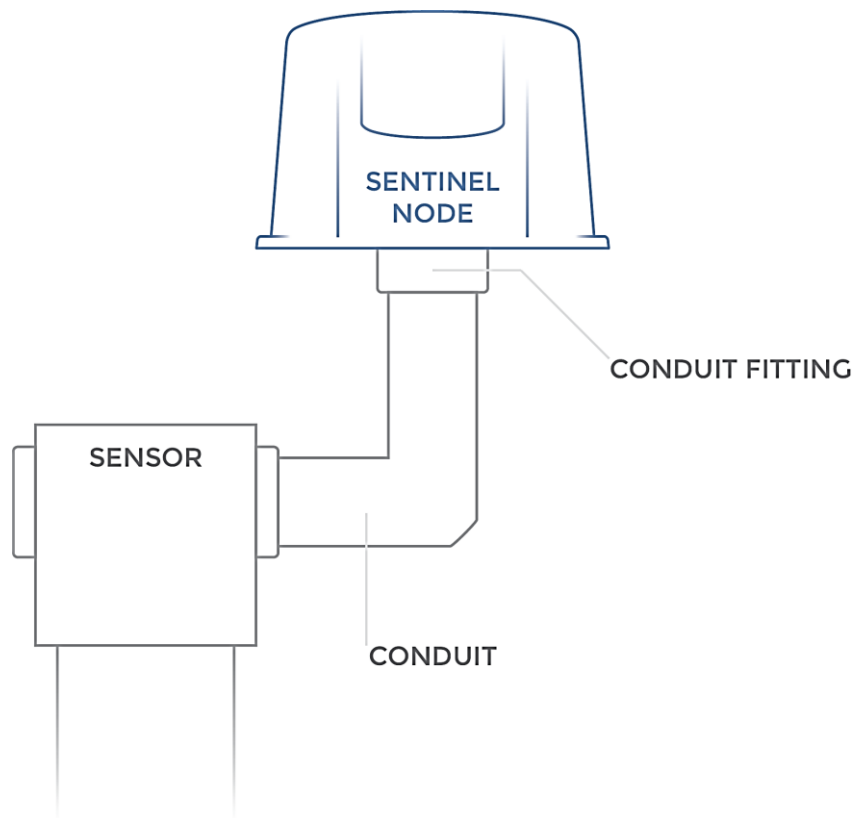

WARNING: The Sentinel must be mounted in a location free of high vibrations. Over time vibrations can damage the Sentinel or battery pack, which could impair its safety ratings. Do not mount directly to continuous vibrating equipment such as pumps or compressors.

Internal Lithium Battery Replacement

Battery Packs can be changed with the node in place.

- 1 Open the cover from the enclosure.
- 2 Unplug the battery from the PCB, by depressing the locking clip on the connector.
- 3 Loosen the screw holding the battery door and slide the old battery out.
- 4 Slide in the new battery pack and tighten the battery door screw.
- 5 Connect the battery to the main PCB battery connector.
- 6 Install the enclosure cover.



WARNING: Use of any battery other than the SignalFire part number 810-0008-02 will impair the protection provided by the equipment.



WARNING: If the internal battery is installed the external solar battery system or other power source may not be connected!

Cleaning Instructions

The outside of the enclosure may be cleaned with water, mild soap, and a damp cloth as needed. High pressure washing is not recommended.



WARNING: Electrostatic Discharge Hazard! Care must be taken to avoid the potential of creating a change on the enclosure or antenna. Do not wipe with a dry cloth. Do not brush against the enclosure with clothing or gloves.



WARNING: Only connect to the debug port in a safe area!

Debug and configuration information is available if a connection is made via the debug port on the main board. A USB converter cable (available from SignalFire) must be used for this interface.

Debug and advanced configuration may be done using the SignalFire Toolkit PC application.

Technical Support and Contact Information

SignalFire Telemetry
 140 Locke Dr, Suite B
 Marlborough, MA 01752
 (978) 212-2868
support@signal-fire.com

Revision	Date	Changes/Updates
1.1	10/09/12	Initial release
1.2	11/7/14	Updated entity parameters
1.3	1/22/15	Added digital input debounce setting
1.4	6/5/15	Updated Design
1.6	8/1/16	Added section on encryption
1.7	9/13/17	Updated warnings
1.8	2/5/19	Updated pictures Minor formatting updates
1.9	3/31/22	Update Register 49987 description.
1.10	6/3/22	Added detail on battery connection

APPENDIX - FCC and IC Statements

16

Changes or modifications not expressly approved by SignalFire Telemetry, Inc could void the user's authority to operate the equipment.

This device complies with Part 15 of the FCC Rules. Operation is subject to the following two conditions: (1) this device may not cause harmful interference, and (2) this device must accept any interference received, including interference that may cause undesired operation.

This equipment has been tested and found to comply with the limits for a Class B digital device, pursuant to Part 15 of the FCC Rules. These limits are designed to provide reasonable protection against harmful interference in a residential installation. This equipment generates, uses and can radiate radio frequency energy and, if not installed and used in accordance with the instructions, may cause harmful interference to radio communications. However, there is no guarantee that interference will not occur in a particular installation. If this equipment does cause harmful interference to radio or television reception, which can be determined by turning the equipment off and on, the user is encouraged to try to correct the interference by one of the following measures:

- Reorient or relocate the receiving antenna.
- Increase the separation between the equipment and receiver.
- Connect the equipment into an outlet on a circuit different from that to which the receiver is connected.
- Consult the dealer or an experienced radio/TV technician for help.

Only the supplied coil antenna (Part number 810-0012-01) which is permanently soldered to the PCB may be used. This antenna has a maximum gain of 3dB.

WARNING!

FCC and IC Radiation Exposure Statement:

This equipment complies with FCC's and IC's RF radiation exposure limits set forth for an uncontrolled environment under the following conditions:

1. This equipment should be installed and operated such that a minimum separation distance of 20cm is maintained between the radiator (antenna) & user's/nearby person's body at all times.
2. This transmitter must not be co-located or operating in conjunction with any other antenna or transmitter.

Under Industry Canada regulations, this radio transmitter may only operate using an antenna of a maximum (or lesser) gain approved for this transmitter by Industry Canada. To reduce potential radio interference to other users, the antenna type and its gain should be so chosen that the equivalent isotropically radiated power (e.i.r.p.) is not more than that necessary for successful communication.

Conformément à la réglementation d'Industrie Canada, le présent émetteur radio peut fonctionner avec une antenne d'un type et d'un gain maximal (ou inférieur) approuvé pour l'émetteur par Industrie Canada. Dans le but de réduire les risques de brouillage radioélectrique à l'intention des autres utilisateurs, il faut choisir le type d'antenne et son gain de sorte que la puissance isotrope rayonnée équivalente (p.i.r.e.) ne dépasse pas l'intensité nécessaire à l'établissement d'une communication satisfaisante.

This device complies with Industry Canada licence-exempt RSS standard(s). Operation is subject to the following two conditions: (1) this device may not cause interference, and (2) this device must accept any interference, including interference that may cause undesired operation of the device.

Le présent appareil est conforme aux CNR d'Industrie Canada applicables aux appareils radio exempts de licence. L'exploitation est autorisée aux deux conditions suivantes : (1) l'appareil ne doit pas produire de brouillage, et (2) l'utilisateur de l'appareil doit accepter tout brouillage radioélectrique subi, même si le brouillage est susceptible d'en compromettre le fonctionnement.